

marantz®

Model SA-KI RUBY Owner's Manual

Super Audio CD Player

You can print more than one page of a PDF onto a single sheet of paper.

Contents

Accessories	2
About the remote control	2
Inserting the batteries	2
Operating range of the remote control unit	2
Features	3
High quality sound	3
High performance	3
Part names and functions	4
Front panel	4
Display	5
Rear panel	6
Remote control unit	7
Connections	8
Connecting an amplifier	8
Connecting to a device with digital audio input connectors	8
Connecting to a device with digital audio output connectors	9
Connecting a USB memory device to the USB port	9
Connecting a PC or Mac	9
Connecting devices with remote control connectors	10
Connection	10
Setting	10
Connecting the timer device	10
Connecting the power cord	10



Playback	11
Basic operation	11
Turning the power on	11
Selecting the playback media mode	11
Having the display and the illumination lamp off	11
Having the illumination lamp always off	11
Stopping digital outputs	12
Setting the top priority playback layer for Super Audio CDs	12
Playing CDs/Super Audio CDs	13
Playing CDs/Super Audio CDs	13
Playing tracks in a specific order (Program playback)	14
Playing Data CDs and Data DVDs	15
Playing files	15
Playing a USB memory device	16
Playing files stored on USB memory devices	16
Using as a D/A converter	18
Connecting and playing back from a computer (USB-DAC)	18
Connect and playback from a digital device (Coaxial/Optical)	22
Specifying the desired sound quality	22
Switching the filter characteristics	22

Settings	23
Menu map	23
Menu operation	23
Phones	24
HP AMP Gain	24
Resume Play	24
AutoStandby	24
Timer Play	24
Tips	25
Tips	26
Troubleshooting	27
Appendix	31
Playable media	31
Discs	31
USB memory device	33
Playback order of music files	34
About discs and files	34
Cautions on using media	34
Loading discs	34
How to handle media	35
Cleaning discs	35
D/A converter	36
Specifications of supported audio formats	36
Explanation of terms	36
Trademark information	37
Specifications	38
Index	40

Thank you for purchasing this Marantz product. To ensure proper operation, please read this owner's manual carefully before using the product. After reading this manual, be sure to keep it for future reference.

Accessories

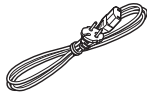
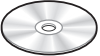
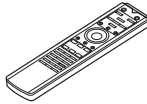
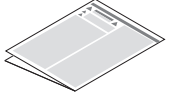
Check that the following parts are supplied with the product.

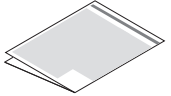
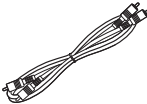
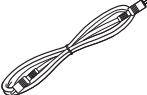
 Quick Start Guide	 Power cord
 CD-ROM (Owner's Manual)	 Remote control unit (RC005PMSA)
 Safety Instructions	 R03/AAA batteries
 Cautions on Using Batteries	 Audio cable
	 Remote connector cable

About the remote control

Inserting the batteries

1 Remove the rear lid in the direction of the arrow and remove it.

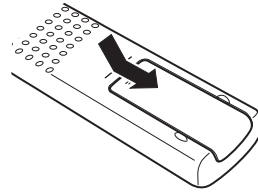

2 Insert two batteries correctly into the battery compartment as indicated.

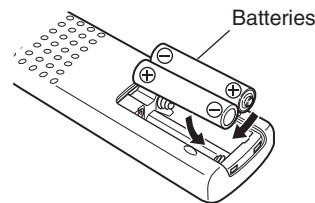

3 Put the rear cover back on.

NOTE

- To prevent damage or leakage of battery fluid:
 - Do not use a new battery together with an old one.
 - Do not use two different types of batteries.
- Remove the batteries from the remote control unit if it will not be in use for long periods.
- If the battery fluid should leak, carefully wipe the fluid off the inside of the battery compartment and insert new batteries.

Operating range of the remote control unit

Point the remote control unit at the remote sensor when operating it.

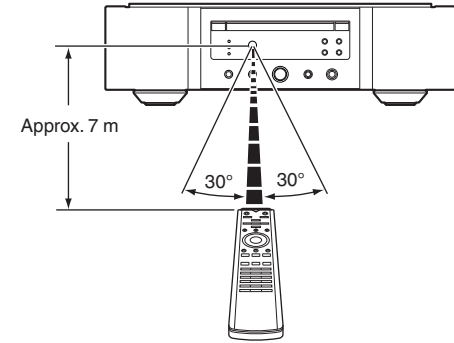

Features

High quality sound

- **Toroidal transformer**
This unit features a toroidal transformer that produces less vibration and magnetic leakage flux compared to conventional power transformers. The materials and manufacturing process of the ring-shaped core are strictly controlled to reduce vibration, while the short-ring attached to the perimeter of the transformer reduce magnetic leakage flux.
- **Large-capacitance block capacitor**
A large capacitance 4700 μ F capacitor carefully selected for its acoustic characteristics is incorporated into the power supply circuit.
- **Audiophile-grade film capacitors and electrolytic capacitors**
The unit's features the same audiophile-grade film capacitors and electrolytic capacitors specifically used in top-range models.
- **Low-noise low-distortion filter circuit and highspeed HDAM®SA3-type output amplifier**
- **Double-layered chassis**
- **High-grade machined analog audio output connectors**
- **High grade headphone circuit**
The high-grade headphone circuit incorporates HDAM®SA2 amplifier to enable headphone listening of high quality sound reproduction, late at night or in other such situations.
- **Isolation design**
To prevent audio quality from degrading due to noise from external devices when this unit is connected to external devices such as computers, the ground circuit for the Digital input interface device is isolated from the audio circuit.
- **Optical Drive off design**
When USB-DAC, Coaxial or Optical input is selected, this unit achieves high quality sound by turning off the drive.

High performance

- **Equipped with a USB-DAC function to support playback of high-resolution sound sources**
This unit supports the playback of high resolution audio formats such as DSD (2.8/5.6/11.2 MHz) and PCM files up to 384 kHz/32 bits. It provides high quality playback of high resolution files into this unit from a computer via USB-B connection.
- **Can be used as a D/A convertor**
Digital audio signals input from an external device or computer into this unit can be converted and output as analog signals using this unit's D/A converter.
- **Supports high-resolution audio sources stored on discs**
MP3, WMA, AAC, WAV, FLAC, ALAC, AIFF and DSD files that have been recorded onto DVD-R/-RW/+R/+RW or CD-R/-RW discs can be played back on this unit.
- **Plays USB memory devices (MP3/WMA/AAC/WAV/FLAC/Apple Lossless/AIFF/DSD)**
You can play back audio files stored on a USB memory device by connecting the USB memory device to the USB port.
- **Peripheral circuitry off function minimizes audio output signal interference**
In order to minimize noise from peripheral circuitry which could interfere with the analog audio signal, this unit is equipped with a peripheral circuitry off function which turns off the digital output circuit, the display, and the illumination lamp.
- **Filter switching function**
Switching between 2 types of filter characteristics is possible during playback in the CD/DAC modes, allowing the listener to enjoy different shadings of the music.

Part names and functions

Front panel

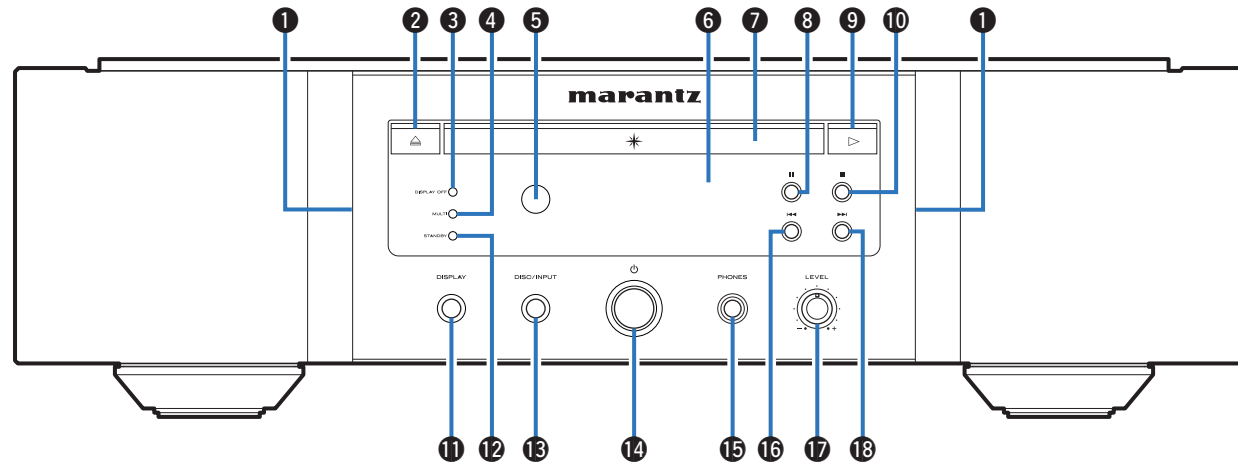

1 Illumination lamp

The illumination lamp lights (blue).

2 Disc tray open/close button (▲)

Opens and closes the disc tray. (☞ p. 13)

3 DISPLAY OFF indicator

Lights when the display is off.
(☞ p. 11)

4 MULTI indicator

This indicator lights up when the Multi channel area of a Super Audio CD is selected. (☞ p. 12)

5 Remote control sensor

This receives signals from the remote control unit.
(☞ p. 2)

6 Display

This displays various pieces of information. (☞ p. 5)

7 Disc tray

Used to insert a disc. (☞ p. 13)

8 Pause button (||)

Pauses playback.

9 Play button (▶)

Playback starts.

10 Stop button (■)

Stops playback.

11 DISPLAY button

This turns the display on/off. Press and hold to turn the illumination lamp on/off.

12 STANDBY indicator

This is lit as follows according to the power status:

- Power on : Off
- Standby : Red
- Power off : Off

13 DISC/INPUT button

Used to select the playback media mode.
(☞ p. 11)

14 Power operation button (⏻)

This turns the power on/off. (☞ p. 11)

15 Headphones jack (PHONES)

Used to connect headphones.

NOTE

- To prevent hearing loss, do not raise the volume level excessively when using headphones.

16 Fast-reverse/Reverse-skip button (◀◀)

Returns to the start of the currently playing track. Press and hold to fast-reverse the track.

17 Headphone volume control knob (LEVEL)

Adjusts the headphone volume.

18 Fast-forward/Forward-skip button (▶▶)

Plays the next track. Press and hold to fast-forward the track.

Display

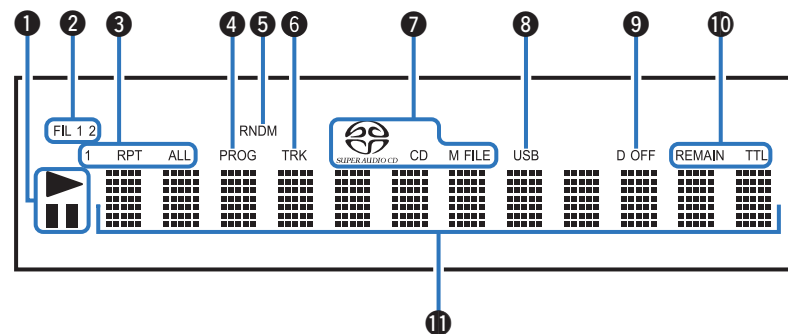

1 Playback mode indicators

- ▶ : Lights up during playback.
- ⏸ : Lights up during pause.

2 Filter indicators (FIL 1 2)

This indicator shows which filter (Filter 1 or Filter 2) is selected. (👉 p. 22)

3 Repeat mode indicators

Lights to match the repeat mode settings.

4 Program indicator (PROG)

Lights up during program playback.

5 Random indicator (RNDM)

Lights during random playback.

6 Track number indicator (TRK)

Lights up when displaying the track number.

7 Disc media indicators

Displays the type of disc that is being played back. "M FILE" lights up when a CD-R/-RW or DVD-R/-RW/+R/+RW is played.

8 USB indicator

This indicator lights up when "USB" is set as the playback media mode.

9 Digital output off indicator (D OFF)

This indicator lights up when the digital output setting is set to off. (👉 p. 12)

10 Time display indicators

REMAIN : This indicator lights up while the remaining track time is displayed.

TTL : This indicator lights up while the total remaining time.

11 Information display

Displays various information or playback elapsed time and so on of the disc.

Rear panel

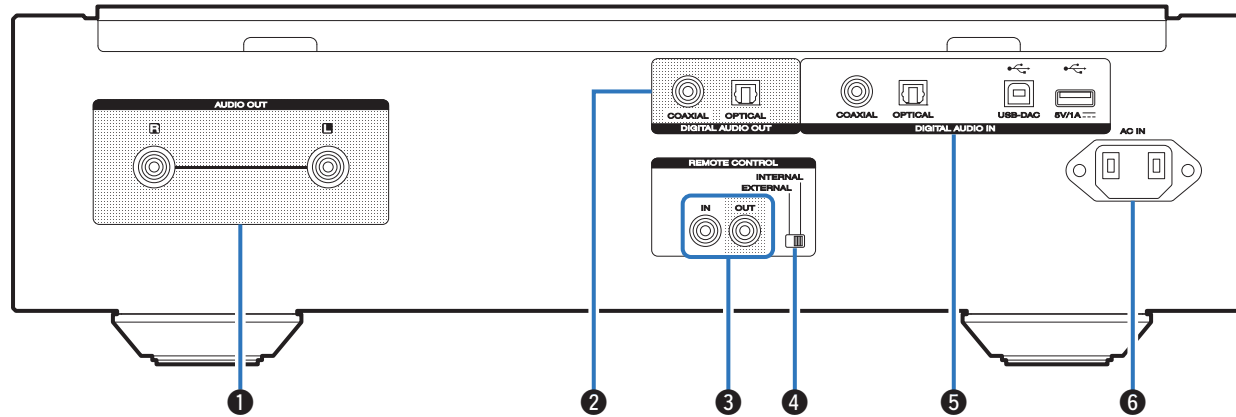

1 AUDIO OUT connectors

Used to connect devices equipped with analog audio inputs connectors or an external power amplifier. (👉 p. 8)

2 DIGITAL AUDIO OUT connectors

Used to connect an AV receiver or D/A converter that has a digital input connectors. (👉 p. 8)

3 REMOTE CONTROL connectors

Used to connect to a Marantz amplifier that is compatible with the remote control function. (👉 p. 10)

4 EXTERNAL/INTERNAL switch

Turn this switch to “EXTERNAL” to operate the unit by pointing the remote control at the amplifier connected to this unit using the remote control connection. (👉 p. 10)

5 DIGITAL AUDIO IN connectors

Used to connect a device with digital audio output connectors (coaxial/optical) or to connect a USB memory device or a computer.

- “Connecting to a device with digital audio output connectors” (👉 p. 9)
- “Connecting a USB memory device to the USB port” (👉 p. 9)
- “Connecting a PC or Mac” (👉 p. 9)

6 AC inlet (AC IN)

Used to connect the power cord. (👉 p. 10)

Remote control unit

□ Operating this unit

To operate CD player, press REMOTE MODE CD button to switch the remote control to the CD operation mode.

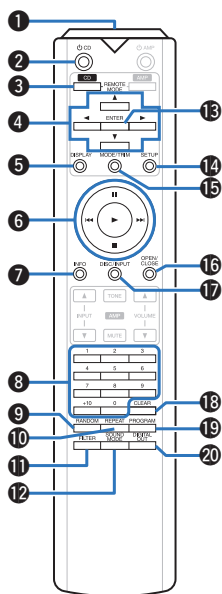

- 1 **Remote control signal transmitter**
This transmits signals from the remote control unit. (☞ p. 2)
- 2 **Power operation button (⏻ CD)**
This turns the power on/off (standby). (☞ p. 11)
- 3 **Remote mode select button (REMOTE MODE CD)**
This switches the remote control operating mode to CD.
- 4 **Cursor buttons (⬆⬇⬅➡)**
These select items.
- 5 **DISPLAY button**
This turns the display on/off. Press and hold to turn the illumination lamp on/off.
- 6 **System buttons**
These perform playback related operations.

- 7 **Information button (INFO)**
This switches the track information shown in the display during playback.
- 8 **Number buttons (0 – 9, +10)**
These enter numbers into the unit.
- 9 **RANDOM button**
Switches the random playback.
- 10 **REPEAT button**
Switches the repeat playback.
- 11 **FILTER button**
This switches the filter characteristics. (☞ p. 22)
- 12 **SOUND MODE button**
This switches the playback layer of a Super Audio CD.
- 13 **ENTER button**
This determines the selection.
- 14 **SETUP button**
This displays the setting menu on the display. (☞ p. 23)
- 15 **MODE/TRIM button**
This switches the playback mode.
- 16 **OPEN/CLOSE button**
Opens and closes the disc tray. (☞ p. 13)
- 17 **DISC/INPUT button**
Used to select the playback media mode. (☞ p. 11)
- 18 **CLEAR button**
This clears the program registration. (☞ p. 14)
- 19 **PROGRAM button**
This sets program playback. (☞ p. 14)
- 20 **DIGITAL OUT button**
This switches the digital audio out on/off. (☞ p. 12)

□ Amplifier operations

A Marantz amplifier can be operated.

To operate the amplifier, press the REMOTE MODE AMP button to switch the remote control to the AMP operation mode.

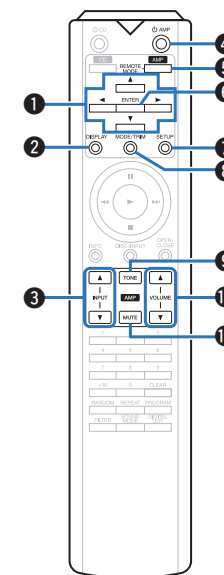

- 1 **Cursor buttons (⬆⬇⬅➡)**
- 2 **DISPLAY button**
- 3 **Input source select buttons (INPUT ▲▼)**
- 4 **Power operation button (⏻ AMP)**
- 5 **Remote mode select button (REMOTE MODE AMP)**
- 6 **ENTER button**
- 7 **SETUP button**
- 8 **MODE/TRIM button**
- 9 **TONE button**
- 10 **VOLUME buttons (▲▼)**
- 11 **MUTE button**



- The remote control may not operate some products.

Connections

Contents

Connecting an amplifier	8
Connecting to a device with digital audio input connectors	8
Connecting to a device with digital audio output connectors	9
Connecting a USB memory device to the USB port	9
Connecting a PC or Mac	9
Connecting devices with remote control connectors	10
Connecting the timer device	10
Connecting the power cord	10

NOTE

- Do not plug in the power cord until all connections have been completed.
- Do not bundle power cords together with connection cables. Doing so can result in noise.

Cables used for connections

Provide necessary cables according to the devices you want to connect.

Audio cable (supplied)	
Remote connector cable (supplied)	
Optical cable (Sold separately)	
Coaxial digital cable (Sold separately)	
USB cable (Sold separately)	

Connecting an amplifier

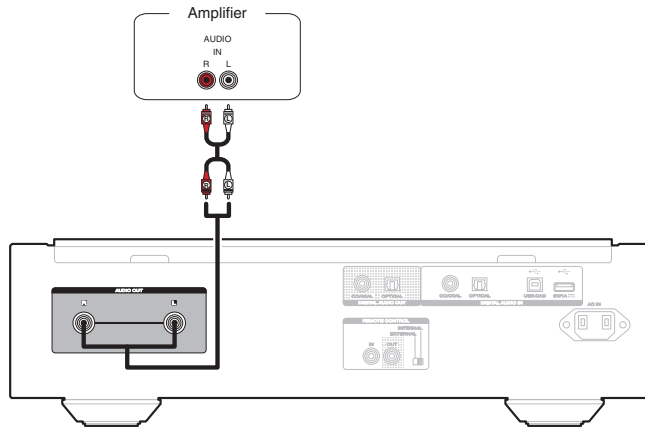

NOTE

- Never insert the short-circuiting pin plug into the AUDIO OUT connectors. Doing so could result in damage.

Connecting to a device with digital audio input connectors

You can enjoy digital audio playback by connecting an AV receiver or D/A converter that has a digital audio terminal to this unit.

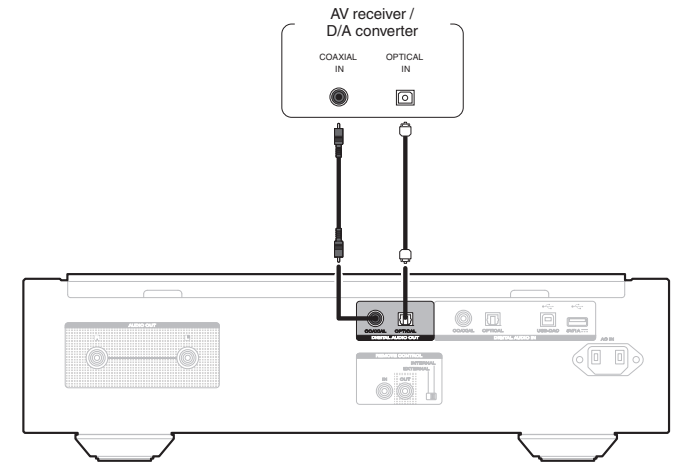

NOTE

- Digital audio output stops during playback of the HD layer of Super Audio CDs and DSD files.
- Digital audio output stops during playback of the DSD files and linear PCM signals with a sampling frequency of 352.8/384 kHz using this unit's D/A converter.
- Never insert the short-circuiting pin plug into the DIGITAL AUDIO OUT (COAXIAL) connector. Doing so could result in damage.

Connecting to a device with digital audio output connectors

Use this connection to input digital audio signals to this unit, and convert the signals for playback using the D/A converter of this unit. (👉 p. 18)

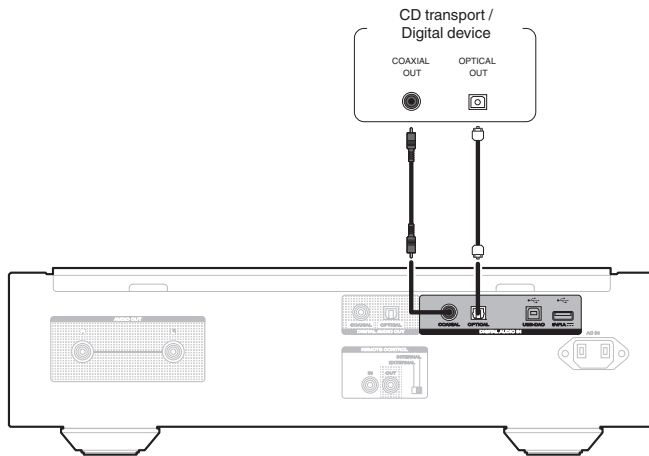

NOTE

- The DIGITAL AUDIO IN (COAXIAL) connector is equipped with a short pin-plug. Remove this plug to connect a external device. Store the removed short pin-plug in a safe place so as not to lose it.

Specifications of supported audio formats

See “D/A converter” (👉 p. 36).

Connecting a USB memory device to the USB port

For operating instructions see “Playing a USB memory device”. (👉 p. 16)

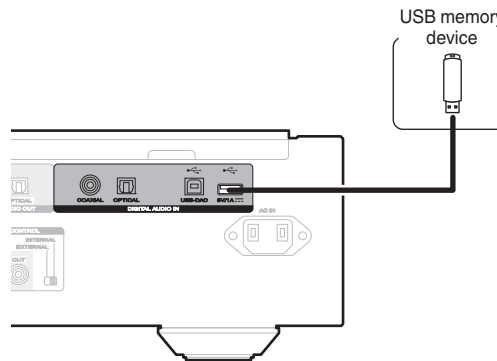

- Marantz does not guarantee that all USB memory devices will operate or receive power. When using a portable USB hard disk drive (HDD) which came with an AC adapter, use that device's supplied AC adapter.

NOTE

- USB memory devices will not work via a USB hub.
- It is not possible to use this unit by connecting the unit's USB port to a PC via a USB cable.
- Do not use an extension cable when connecting a USB memory device. This may cause radio interference with other devices.

Connecting a PC or Mac

By connecting a computer to the USB-DAC port on the rear panel of this unit using a commercially available USB connecting cable, this unit can be used as a D/A converter. (👉 p. 18)

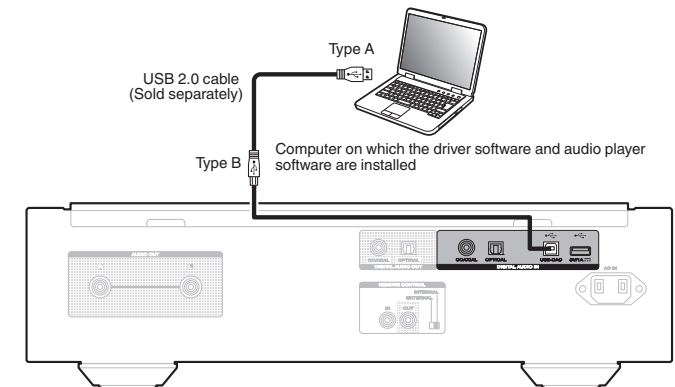

- Before USB connecting this unit to your computer, install the driver software in your computer. (👉 p. 18)
- Download the driver software from the SA-KI RUBY page of the Marantz website.

NOTE

- Use a cable that is 3 m or less to connect to the computer.

Connecting devices with remote control connectors

When you use this unit connected to a Marantz amplifier, this unit receives operation signals sent from the amplifier and operates accordingly.

Next, configure the “Connection” and “Setting”.

Connection

Use the supplied remote connector cable to connect the REMOTE CONTROL IN connector of this unit to REMOTE CONTROL OUT connector of the amplifier.

Setting

Turn the EXTERNAL/INTERNAL switch on the unit to “EXTERNAL”.

- This setting will disable remote sensor reception of this unit.
- To operate the unit, point the remote control at the remote sensor of the amplifier.



- To use this unit by itself without connecting an amplifier, turn the switch to “INTERNAL”.

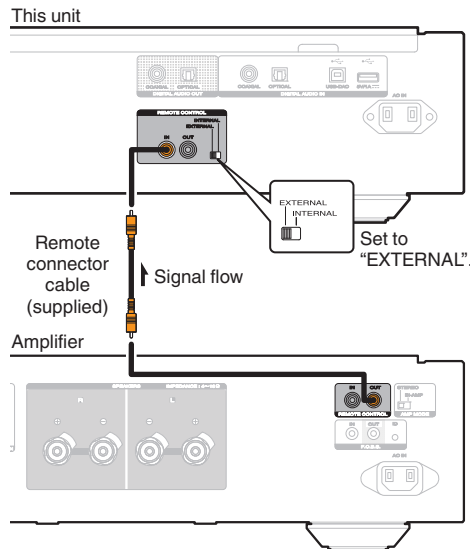

Connecting the timer device

This unit can perform timer play when an amplifier and timer device are connected to this unit.
 (“Timer Play” (🔧 p. 24))

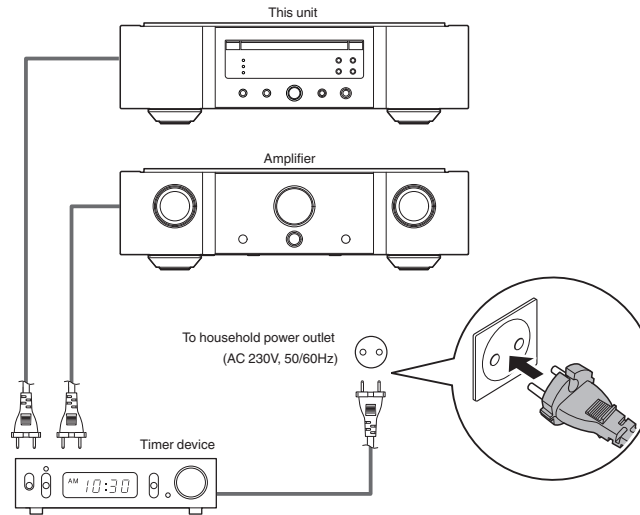

Connecting the power cord

After completing all the connections, insert the power plug into the power outlet.

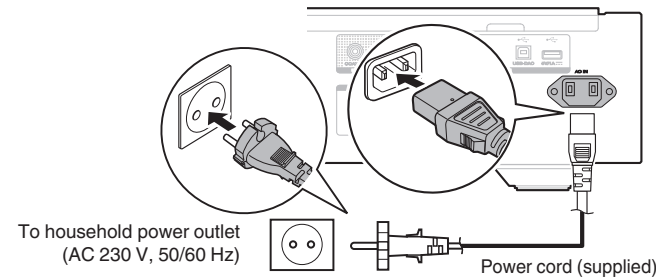

Playback

□ Contents

Basic operation	11
Playing CDs/Super Audio CDs	13
Playing Data CDs and Data DVDs	15
Playing a USB memory device	16
Using as a D/A converter	18
Specifying the desired sound quality	22

Basic operation

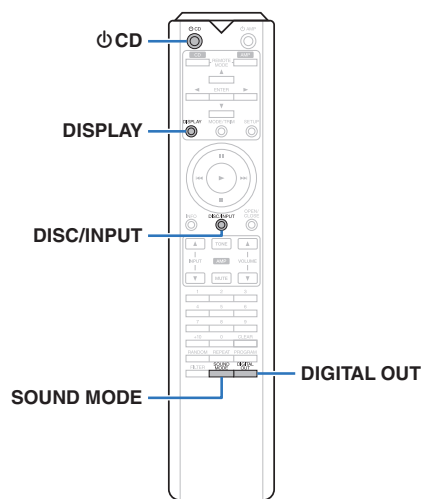

Turning the power on

1 Press **CD** on the main unit to turn the power on.



- Press **CD** on the remote control unit to turn on power from standby mode.
- You can also press **▶** on the main unit to turn on power from standby mode.

□ When power is switched to standby

1 Press **CD**.
The unit switches to standby mode, and the STANDBY indicator lights red.

NOTE

- Power continues to be supplied to some of the circuitry even when the power is in the standby mode. When leaving home for long periods of time or when going on vacation, either press **CD** on the main unit to turn off the power, or unplug the power cord from the power outlet.

Selecting the playback media mode

1 Press **DISC/INPUT** to select the playback media mode.

Disc (Default):	Select to playback a disc.
USB:	Select to playback a USB memory device.
USB-DAC:	Plays back audio files on the computer.
Coaxial:	Plays back the device connected to the COAXIAL connector.
Optical:	Plays back the device connected to the OPTICAL connector.



- You can also select the playback media mode by pressing **DISC/INPUT** on the unit.

Having the display and the illumination lamp off

The display circuit operation can be stopped to minimize noise from the display and the display circuit which could interfere with the analog audio output signal.

1 During playback, press **DISPLAY**
Each time you press **DISPLAY**, the display and the illumination lamp (blue) switch on/off at the same time.



- When the display is switched off, the "DISPLAY OFF" indicator lights.
- If you press **DISPLAY** at any time other than during playback, the display and the illumination lamp (blue) do not light off.

Having the illumination lamp always off

The following procedure makes the illumination lamp always off regardless of the display on/off operation.

1 Press and hold **DISPLAY** for two seconds and longer while display is lighted.
Press and hold **DISPLAY** for two seconds and longer while the lamp is always off to return to the normal setting.

Stopping digital outputs

Stopping digital audio output reduces a source of noise that affects sound quality, enabling higher sound quality playback.

1 Press DIGITAL OUT.

The digital audio output is switched on and off each time the button is pressed.

- When digital output is turned off, the “D OFF” indicator lights up on the display.

Setting the top priority playback layer for Super Audio CDs

The layer that is played with priority when the disc is loaded can be set.

1 Press DISC/INPUT to switch the playback media mode to “Disc”.

2 Check that no disc is loaded.

- If the layer is switched while the disc is being loaded, the playback layer switches for that disc, but the top priority playback layer setting itself does not change.

3 Press SOUND MODE and switch to the layer you want to set.

STEREO (Default):	Plays back the 2-channel area of the Super Audio CD.
MULTI:	Plays back the multi-channel area of the Super Audio CD. The analog output of this unit outputs a down-mixed 2-channel signal.
CD:	Plays back the CD layer of the Super Audio CD.



- When a disc is loaded after the setting has been made, the contents recorded on the set layer are displayed.
- If a disc that does not contain the layer set for top priority playback is loaded, the contents recorded on another layer are displayed automatically.
- This setting is stored in the memory and is not cleared even when the disc holder is opened or closed or the power is turned off. To change the setting, repeat the procedure above.
- The priority playback layer cannot be set when a disc is inserted or “Open” is shown on the display.
- If the area and layer have not been set for a disc, the priority playback order is as follows:
 - ① STEREO
 - ② MULTI
 - ③ CD

Playing CDs/Super Audio CDs

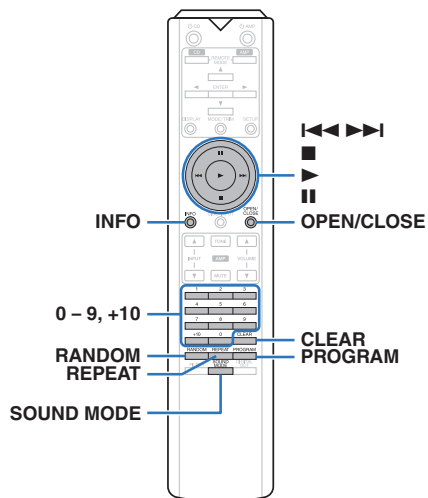

Playing CDs/Super Audio CDs

1 Press OPEN/CLOSE to insert a disc.

(☞ p. 34)

The playback media mode automatically switches to "Disc".

- You can also open/close the disc tray by pressing ◀▶ on the unit.
- You can also close the display by pressing ▶. This automatically starts playback.

2 When playing back a Super Audio CD, press SOUND MODE to set the playback layer.

(☞ p. 12)

3 Press ▶.

The ▶ indicator lights on the display. Playback starts.

NOTE

- Do not place any foreign objects in the disc tray. Doing so could damage the unit.
- Do not push the disc tray in by hand when the power is turned off. Doing so could damage the unit.

Operation buttons	Function
▶	Playback
⏸	Pause
■	Stop
⏮, ⏭	Skip to previous track / Skip to next track
⏮, ⏭ (Press and hold)	Fast-reverse / Fast-forward
0 - 9, +10	Select the track
REPEAT	Repeat playback <ul style="list-style-type: none"> • Switching between All-track repeat and Single-track repeat.
RANDOM	Random playback
	Time display switching <ul style="list-style-type: none"> • Switching between elapsed time of the current track, remaining time of the current track and remaining time of all tracks.
INFO	<ul style="list-style-type: none"> • The time displayed on this unit may differ from this actual time, as it is calculated by truncating to the nearest 1 second. <p>Text information recorded on the Super Audio CD appears in the display.</p>

❑ Switching the display

Press INFO.

Displays text and time information stored on media.

- The text information is only displayed for Super Audio CD.
- The player can display the following characters:

```

ABCDEFGHIJKLMNPOQRSTUVWXYZ
abcdefghijklmnopqrstuvwxyz
0123456789
!"#$%&:;<>?@[ ]_`{|}~^'()*+,-./=
(space)

```

❑ Discs that can be played back

- See "Discs". (👉 p. 31)

❑ Playing a specific track (Direct searching)

1 Use 0 – 9, +10 to select the tracks.

[Example]

Track 4 :

Press number 4 to select track 4.

Track 12 :

Press numbers 1 and 2 consecutively to select track 12.

- The number you enter is set about 1.5 seconds after you press the number buttons. To enter a two-digit number, be sure to press the two number buttons, one immediately after the other.

Playing tracks in a specific order (Program playback)

Up to 20 tracks can be programmed.

1 In the stop mode, press PROGRAM.

The "PROG" indicator on the display lights.

2 Use 0 – 9, +10 to select the tracks.

[Example]

Track 4 : Press number 4 to select track 4.

Track 12 : Press numbers 1 and 2 consecutively to select track 12.

- The number you enter is set about 1.5 seconds after you press the number buttons. To enter a two-digit number, be sure to press the two number buttons, one immediately after the other.

3 Press ►.

Playback starts in the programmed order.



- When REPEAT is pressed during program playback, the tracks are played repeatedly in the programmed order.

NOTE

- The program is cleared when the disc tray is opened or the power is turned off.

❑ Checking the order of the programmed tracks

In the stop mode, press ►►.

The tracks are shown in the programmed order in the display each time ►► is pressed.

❑ To clear the last track programmed

In the stop mode, press CLEAR.

The last track programmed is cleared each time the button is pressed.

❑ Clearing the all programmed track

In the stop mode, press PROGRAM.

Playing Data CDs and Data DVDs

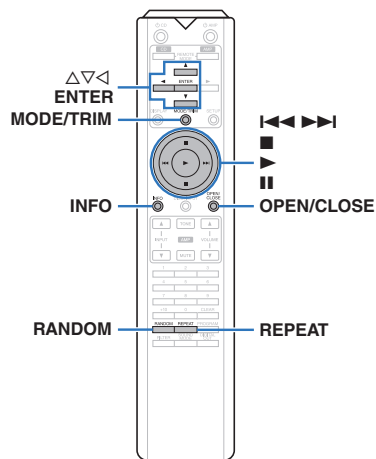

- This section explains how to playback music files that are recorded onto a CD-R/-RW or DVD-R/-RW/+R/+RW.
- There are many music distribution sites on the Internet allowing you to download music files in MP3 or WMA (Windows Media® Audio) format. The music (files) downloaded from such sites can be stored on CD-R/-RW or DVD-R/-RW/+R/+RW discs and played on this unit.
- The audio format types and specifications supported by this unit for playback are as follows.
See "Playable files" for details. (☞ p. 32)
 - MP3/WMA/AAC/WAV/FLAC/Apple Lossless/AIFF/DSD

NOTE

- Copyright-protected files cannot be played.
- Note that depending on the software used for burning and other conditions, some files may not play or display correctly.

"Windows Media" and "Windows" are the trademarks or registered trademarks of Microsoft Corporation in the United States and other countries.

Playing files

- Load a CD-R/-RW or DVD-R/-RW/+R/+RW disc containing music files into the disc tray. (☞ p. 34)
 - Press OPEN/CLOSE to open/close the disc tray.
- Use $\Delta \nabla \triangleleft$ to select the folder to be played, then press ENTER.
- Use $\Delta \nabla$ to select the file to be played, then press ENTER.
Playback starts.

Operation buttons	Function
\blacktriangleright	Playback
\parallel	Pause
\blacksquare	Stop
$\blacktriangleleft \blacktriangleright$	Skip to previous track / Skip to next track
$\blacktriangleleft \blacktriangleright \blacktriangleleft \blacktriangleright$	(Press and hold) Fast-reverse / Fast-forward
\triangleleft	Moving up a level in the folder tree
$\Delta \nabla$	Select the item
ENTER	Enter the selected item / Playback
MODE/TRIM	Select the playback range
RANDOM	Random playback
REPEAT	Repeat playback <ul style="list-style-type: none"> Switching between All-track repeat and Single-track repeat.
INFO	Switch the display between the elapsed playback time, text information and the file format.



- To start playing another file during playback of a CD-R/CD-RW or DVD-R/-RW/+R/+RW, first press \triangleleft to display the file tree. Next, use $\Delta \nabla$ to select the file to be played and press ENTER.

Switching the display

During playback, press INFO.

- Switch the display between the elapsed playback time, text information and the file format.
- If a file does not support text information or no track information is recorded, the file name is displayed.
- The player can display the following characters:

```

ABCDEFGHIJKLMN OPQRSTUVWXYZ
abcdefghijklmnopqrstu vwxyz
0123456789
!"#$%& :;<>?@\[_`!{ }~^'()*+,-./=
(space)
  
```

- The file numbers are set automatically when the disc is loaded.

Files that can be played back

- See "Playable files". (☞ p. 32)

Switching the playback range

In the stop mode, press MODE/TRIM.

- The playback range of a track can be set.

Folder mode:	All the files in the selected folder are played.
All mode:	All the files in the disc are played.



- The folder hierarchy is not displayed when "All mode" is set as the playback range.

Playing a USB memory device

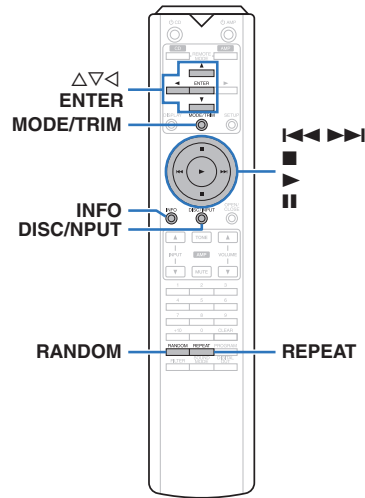

- Playing back music stored on a USB memory device.
- Only USB memory devices conforming to mass storage class standards can be played on this unit.
- This unit is compatible with USB memory devices in “FAT16” or “FAT32” format.
- The audio format types and specifications supported by this unit for playback are as follows.
For details, see “USB memory device” (p. 33).
 - **MP3/WMA/AAC/WAV/FLAC/Apple Lossless/AIFF/DSD**

Playing files stored on USB memory devices

1 Connect the USB memory device to the USB port. (p. 9)

2 Press DISC/INPUT to switch the playback media mode to “USB”.



- When the menu’s “Resume Play” (p. 24) is on, playback starts automatically.

3 Press ◀.

The file/folder list appears in the display of this unit.



- The file/folder list can also be displayed by pressing ■ to stop the playback.

4 Use ▲▼ to select the folder, then press ENTER.

5 Use ▲▼ to select the file, then press ENTER.
Playback starts.

Operation buttons	Function
▶	Playback
⏸	Pause
■	Stop
⏮, ⏭	Skip to previous track / Skip to next track
⏪, ⏩	(Press and hold) Fast-reverse / Fast-forward
◀	Moving up a level in the folder tree
▲ ▼	Select the item
ENTER	Enter the selected item / Playback
REPEAT	Repeat playback <ul style="list-style-type: none"> • Switching between All-track repeat and Single-track repeat.
RANDOM	Random playback
MODE/TRIM	Switch to Folder playback mode <ul style="list-style-type: none"> • Switching between “Folder” or “All” mode.
INFO	This switches between the elapsed playback time and text information.



- To start playing another file during playback of a USB memory device, first press ◀ to display the file tree. Next, use ▲▼ to select the file to be played and press ENTER.

NOTE

- Do not remove the USB memory device from the unit when the USB memory communication indicator is flashing. Doing so may damage the USB memory device, or may corrupt the files recorded on the USB memory device.
- Note that Marantz will accept no responsibility whatsoever for any problems arising with the data on a USB memory device when using this unit in conjunction with the USB memory device.

❑ Switching the display

During playback, press INFO.

- This switches between the elapsed playback time and text information.
- While a WAV, AIFF or DSD (.dff) file is being played back, the file name, file number and file format are displayed.
- The player can display the following characters:

ABCDEFGHIJKLMNOPQRSTUVWXYZ

abcdefghijklmnopqrstuvwxyz

0123456789

! " # \$ % & ; : < > ? @ \ [] _ ` | { } ~ ^ ' () * + , - . / =

(space)

- A period (“.”) is displayed instead of any character that cannot be displayed by the player.

❑ Files that can be played back

See “USB memory device” (🔗 p. 33).

❑ Switching the playback range

In the stop mode, press MODE/TRIM.

- The playback range of a track can be set.

Folder mode:	All the files in the selected folder are played.
All mode:	All the files in the USB memory are played.



- The folder hierarchy is not displayed when “All mode” is set as the playback range.

Using as a D/A converter

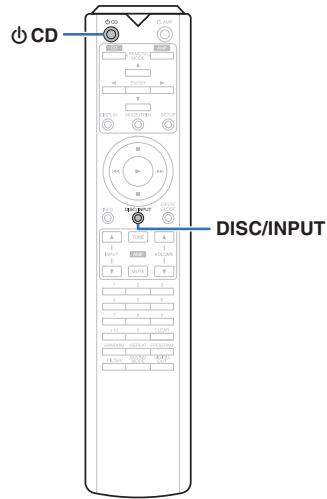

Digital audio signals input from an external device or computer into this unit can be converted and output as analog signals using this unit's D/A converter. (D/A converter function)

- DSD is a registered trademark.
- Microsoft, Windows 7, Windows 8, Windows 8.1 and Windows 10 are either registered trademarks or trademarks of Microsoft Corporation in the United States and/or other countries.
- ASIO is a trademark of Steinberg Media Technologies GmbH.
- Apple, Macintosh and Mac OS are trademarks of Apple Inc., registered in the U.S. and other countries.

Connecting and playing back from a computer (USB-DAC)

You can enjoy high-quality audio playback from the D/A converter built in to this unit by inputting music files into this unit from a computer via USB connection.

- Before USB connecting this unit to your computer, install the driver software in your computer.
- Drivers do not need to be installed for Mac OS.
- Also, you can use whichever commercially available or downloadable player software you like to playback files on your computer.

❑ Computer (system requirements)

OS

- Windows 7, Windows 8, Windows 8.1 or Windows 10
- Mac OS X 10.10, 10.11 or macOS 10.12

USB

- USB 2.0: USB High speed/USB Audio Class Ver. 2.0

NOTE

- This unit was checked the operation using the system requirements by us, but it does not guarantee the operation of all systems.

Windows OS Installing the dedicated driver (🔗 p. 18)

Mac OS Audio Device Settings (🔗 p. 21)

❑ Installing the dedicated driver (Windows OS only)

❑ Installing the driver software

- 1 Disconnect the USB cable between your PC and the unit.**
 - The driver software cannot be installed correctly if your PC is connected to the unit by a USB cable.
 - If the unit and your computer are connected by a USB cable and the computer is switched on before installation, disconnect the USB and restart the computer.
- 2 Download the dedicated driver from the “Download” section of the SA-KI RUBY page of the Marantz website onto your PC.**
- 3 Unzip the downloaded file, and double-click the exe file.**
- 4 Install the driver.**
 - ① Select the language to use for the installation.
 - ② Click “OK”.

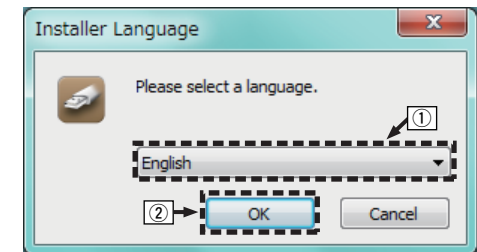

③ The wizard menu is displayed. Click “Next”.

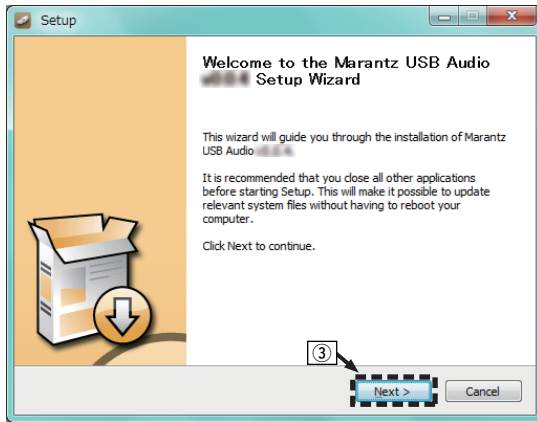

④ Read the Software Licensing Agreement, and click “I accept the terms of the License Agreement”.

⑤ Click “Next”.

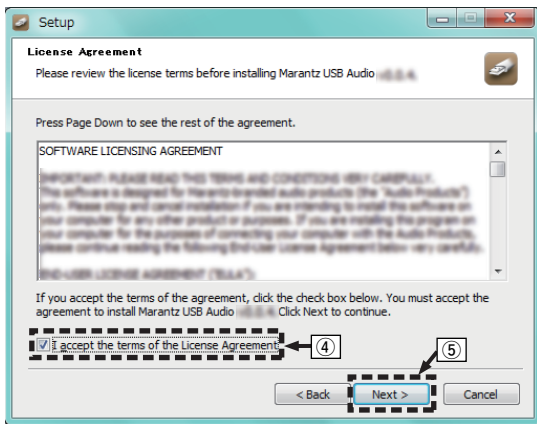

⑥ Click “Install” on the installation start dialog.

- The installation starts. Do not perform any operation on the PC until the installation is completed.

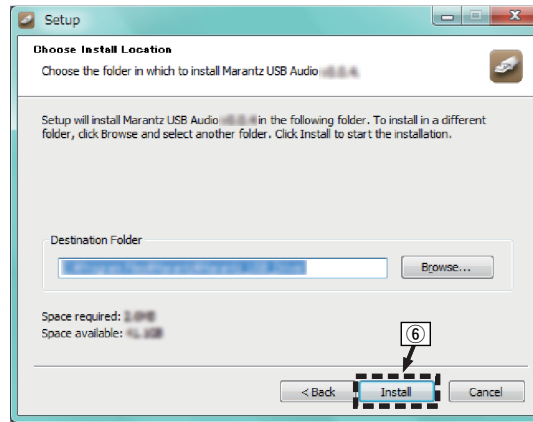

⑦ Click “Next”.

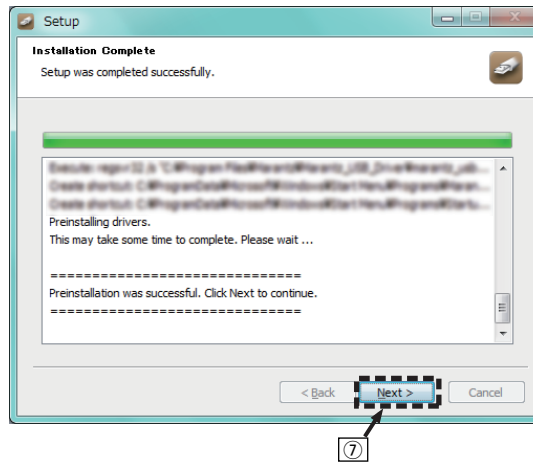

⑧ When the installation is completed, click “Finish”.

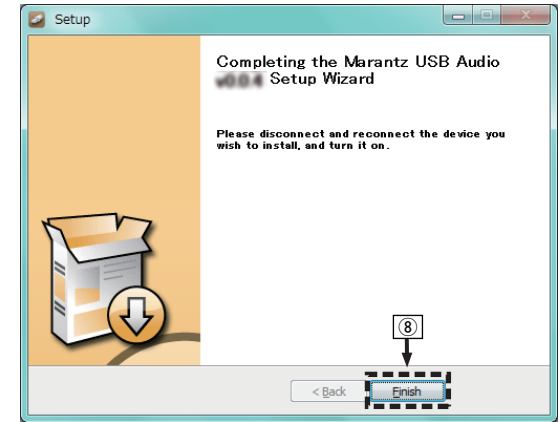

⑨ Click “Yes”.



5 With the unit power off, connect the unit and PC using a USB cable (sold separately).

- For the connection procedure, refer to the “Connecting a PC or Mac” section. (p. 9)

6 Press the main unit's .

- When the unit power is turned on, the PC automatically finds and connects to the unit.

7 Press DISC/INPUT to switch the playback media mode to “USB-DAC”.

8 Checking the installed driver.

- Click the “Start” button and click “Control Panel” on the PC.
 - The control panel setting list is displayed.
- Click “Sound”.
 - The sound menu window is displayed.
- Check that there is a checkmark next to “Default Device” under in “SA-KI RUBY” of the “Playback” tab.
 - When there is a checkmark for a different device, click “SA-KI RUBY” and “Set Default”.

9 Checking audio output.

Outputs a TEST signal from the PC and checks the audio output from the USB-DAC function.

- Select “SA-KI RUBY” and click “Properties”.
 - The SA-KI RUBY Properties window is displayed.

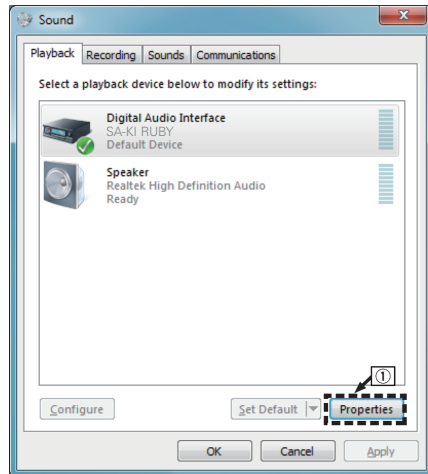

- Click the “Advanced” tab.
- Select the sampling rate and bit rate to be applied to the D/A converter.
 - It is recommended that “2 channel, 24 bit, 192000 Hz (Studio Quality)” is selected (Windows 7).
 - It is recommended that “2 channel, 32 bit, 192000 Hz (Studio Quality)” is selected (Windows 8/Windows 8.1/Windows 10).
- Click “Apply”.
- Click “Test”.
 - Check that audio from this unit is output from the PC.

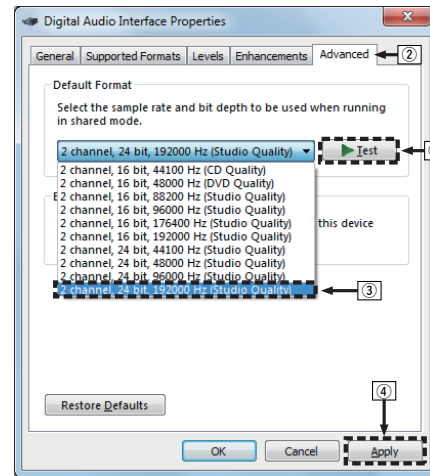

NOTE

- The dedicated driver must be installed in the PC before this unit is connected to a PC. Operation will not occur correctly if connected to the PC before the dedicated driver has been installed.
- Player software supporting the Audio Stream Input Output (ASIO) driver is required to play files with a sampling frequency of 352.8 kHz/384 kHz without downsampling. Check your player software before playing files with the ASIO driver.
- Operation may fail in some PC hardware and software configurations.
- Please see the FAQ at www.marantz.com if you experience any issues getting audio to play from your computer through the this unit. You may also want to check the support pages for your audio player application.

❑ Audio device settings (Mac OS only)

- ① With the unit power off, connect the unit and Mac using a USB cable (sold separately).
 - For the connection procedure, refer to the “Connecting a PC or Mac” section. (📖 p. 9)
- ② Press the main unit’s **⏻**.
- ③ Press DISC/INPUT to switch the playback media mode to “USB-DAC”.
- ④ Move the cursor to “Go” on the computer screen, and then click “Utilities”.
 - The utility list is displayed.
- ⑤ Double-click “Audio MIDI Setup”.
 - The “Audio Devices” window is displayed.
- ⑥ Check that “Use this device for sound output” is checked in “SA-KI RUBY”.
 - If a different device is checked, select and “Secondary click” on “SA-KI RUBY”, and then select “Use this device for sound output”.

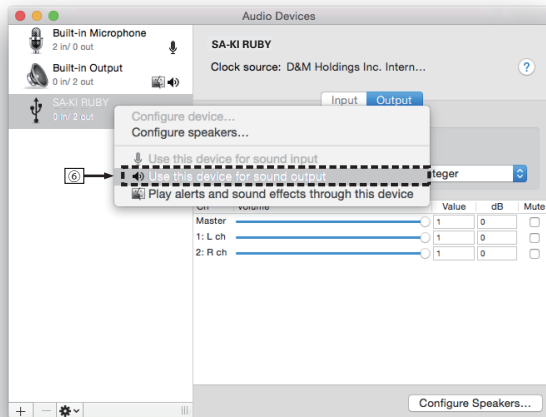

- ⑦ Select the “SA-KI RUBY” format.
 - It is normally recommended to set the format to “384000.0 Hz” and “2ch-32 bit Integer”.

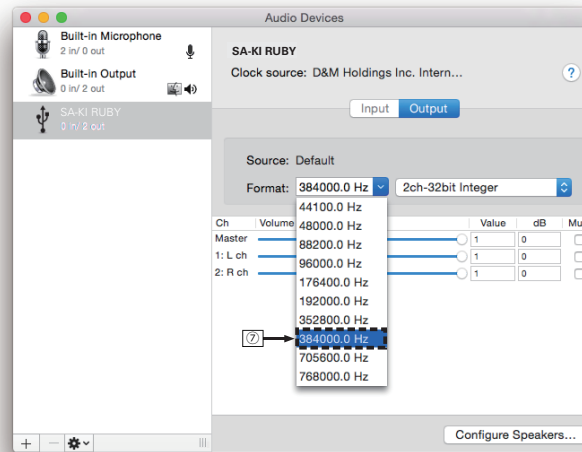

- ⑧ Quit Audio MIDI Setup.

❑ Playback

Install the desired player software on your computer beforehand.

Use the rear panel USB-DAC port to connect this unit to a computer. (📖 p. 9)

1 Press DISC/INPUT to switch the playback media mode to “USB-DAC”.

Start playback on the computer’s player software. The digital audio signal that is being input is shown as follows in the display.

- When a linear PCM signal is input
[Example] PCM176.4k/24



- Files are displayed in order of sampling frequency and bit length.
- The displayed bit length is the bit count at the time the audio signal is input from the computer to the D/A converter of this unit.

- When a DSD signal is input
[Example] DSD 11.2M



- Only the sampling frequency is displayed when a DSD signal is input.



- If the sampling frequency cannot be detected, “Unlock” will be displayed.
- “Unsupported” is displayed when audio signals that are not supported by this unit are input.

□ Audio signals that can be played back

See “D/A converter” (🔗 p. 36).

NOTE

- Perform operations such as playback and pause on the computer. At this time, you cannot perform operations with buttons on this unit or the remote control.
- When this unit is functioning as a D/A converter, sound is not output from the computer’s speakers.
- If the computer is disconnected from this unit while the computer music playback software is running, the playback software may freeze. Always exit the playback software before disconnecting the computer.
- When an error occurs on the computer, disconnect the USB cable and restart the computer.
- The sampling frequency/bit length of the music playback software and sampling frequency/bit length displayed on this unit may differ.
- Use a cable that is 3 m or less to connect to the computer.

Connect and playback from a digital device (Coaxial/Optical)

1 Press DISC/INPUT to switch the playback media mode to “Coaxial” or “Optical”.

The digital audio signal that is being input is shown as follows in the display.

- When a linear PCM signal is input

【Example】PCM176.4k/24



- Files are displayed in order of sampling frequency and bit length.
- The displayed bit length is the bit count at the time the audio signal is input from the external device to the D/A converter of this unit.



- If the sampling frequency cannot be detected, “Unlock” will be displayed.
- “Unsupported” is displayed when audio signals that are not supported by this unit are input.

□ Specifications of supported audio formats

See “D/A converter” (🔗 p. 36).

NOTE

- Do not input non-PCM signals, such as Dolby Digital and DTS. This causes noise and could damage the speakers.

Specifying the desired sound quality

Switching the filter characteristics

This unit is equipped with a sound quality adjusting function which allows users to enjoy the desired playback sound quality. The unit supports PCM signal.

The 2 filter characteristics types are explained below.

Filter Type	Features
Filter 1	Very short but symmetrical impuls response. Very precise soundstage and smooth tonal balance.
Filter 2	Very short pre-ringing - long post-ringing. Neutral tonal balance - slightly brighter than “Filter1”.

1 Press FILTER

The setting cycles through the 2 modes (Filter 1 / Filter 2) as shown below each time the button is pressed.

NOTE

- The filter characteristics have a last memory function. These settings remain in memory even if a disc change occurs, or if the power is turned off.
- The filter function does not work during playback of Super Audio CDs or DSD audio sources.

Settings

Menu map

By default, this unit has recommended settings defined. You can customize this unit based on your existing system and your preferences.

Setting items	Description	Page
Phones	Switches the headphones output on/off.	<u>24</u>
HP AMP Gain	Set the gain of the headphone amplifier.	<u>24</u>
Resume Play	When the playback media mode is switched, the USB memory device is disconnected and then connected, or the power is turned off and then back on during USB memory device playback, the unit memorizes the point where playback stopped so that playback can resume from the beginning of that track.	<u>24</u>
AutoStandby	Sets whether to automatically switch the unit to the standby mode when the unit remains in the stop mode for more than 30 minutes.	<u>24</u>
Timer Play	This unit can perform timer play by cooperating with your timer device.	<u>24</u>

Menu operation

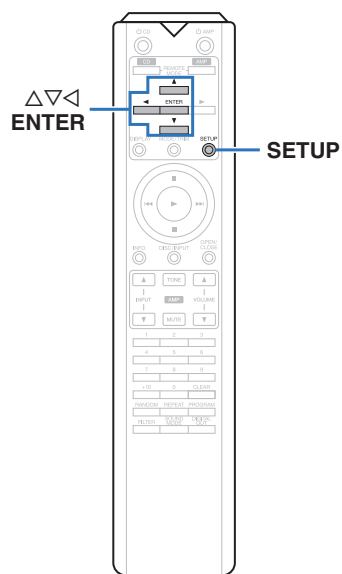

- 1 Press SETUP.**
The menu is displayed on the display.
- 2 Use $\Delta\nabla$ to select the menu to be set or operated, then press ENTER.**
- 3 Use $\Delta\nabla$ to change to desired setting.**
- 4 Press ENTER to enter the setting.**
 - To return to the previous item, press \triangleleft .
 - Exiting the Menu, press SETUP while the menu is displayed. The display returns to the normal display.

Phones

The headphones circuit operation can be stopped to minimize noise from the headphones circuit which could interfere with the analog audio output signal.

On (Default):	Enable the headphones output.
Off:	Disable the headphones output.



- When not using headphones, you can enjoy higher quality sound with Off mode.

HP AMP Gain

Set the gain of the headphone amplifier. Set this according to the impedance of the connected headphones. It is recommended that this is set on the “Low” side if the headphones have low impedance and on the “High” side if they have high impedance.

Low (Default):	Set the gain of the headphone amplifier to “Low”.
Middle:	Set the gain of the headphone amplifier to “Middle”. Set this if the volume is too low at the factory default setting.
High:	Set the gain of the headphone amplifier to “High”. Set when there is insufficient volume, even when the gain setting is “Middle”.

NOTE

- The headphone volume varies depending on the “HP AMP Gain” setting. Decrease the volume or mute the audio first if changing this setting while listening to audio.

Resume Play

When the playback media mode is switched, the USB memory device is disconnected and then connected, or the power is turned off and then back on during USB memory device playback, the unit memorizes the point where playback stopped (resume information) so that playback can resume from the beginning of that track.

On (Default):	Resume playback is set.
Off:	Resume playback is not set.

NOTE

- Resume playback works even if the USB memory device is disconnected and then reconnected. However, if a different USB memory device is connected, the resume information for the previous USB memory device is deleted.
- The resume information may be deleted when the USB memory device is removed and files are added or deleted.
- Press **■** while playback is stopped to delete the resume information. “Resume Off” is displayed.
- Resume information is not recorded when the power is turned off by pressing **⏻** during USB memory device playback.

AutoStandby

Sets whether to automatically switch the unit to the standby mode when the unit remains in the stop mode for more than 30 minutes.

On (Default):	Enable Auto Standby mode.
Off:	Disable Auto Standby mode.

Timer Play

This unit can perform timer play by cooperating with your timer device.

(“Connecting the timer device” (🔗 p. 10))

On:	Timer play is set. Select the playback media mode to be used for timer play.
Off (Default):	Timer play is not set.

❑ Using the timer play function

- Turn on the power of the connected components.
- Load a disc or connect a USB memory device.
- Switch the media mode of this unit to the media to be played using the timer.
- Switch the amplifier’s function to input from the connected unit.
- Set the audio timer for the desired times.
- Turn the timer on.

The power of the components connected to the timer turns off.

When the set time is reached, the power of the different components automatically turns on and playback starts from the first track.

NOTE

- For connection to audio timer and its operation, please refer to the instruction manual of your audio timer.
- The timer play does not support the random playback, repeat playback or program playback.

Tips

□ Contents

Tips

I want to switch the filter to change the desired sound quality	26
I want to enjoy analog output audio at higher quality	26
I want to turn the illumination lamp off	26
I want to display Super Audio CD text	26
I want to play the multi-channel area of a Super Audio CD is played	26
I want to play all tracks on a DVD-R/-RW/+R/+RW or CD-R/-RW at random	26
I want to playback just the specified folder	26
I want to stop the USB memory device from automatically starting playback	26
I want to use this unit's remote control to operate a Marantz amplifier	26

Troubleshooting

Power does not turn on / Power is turned off	27
Operations cannot be performed through the remote control unit	27
Display on this unit shows nothing	28
No sound comes out	28
Sound is interrupted or noise occurs	28
Desired sound does not come out	28
Cannot playback Discs	29
PC or Mac files cannot be played back	29
Audio from digital devices cannot be played back (Coaxial/Optical)	29
The bit length displayed for files played back from a computer or external device is different from the bit length displayed on this unit	30
USB memory devices cannot be played back	30
Text informations on the USB memory device are not displayed properly	30

Tips

I want to switch the filter to change the desired sound quality

- Switch the filter characteristics. (🔗 p. 22)

I want to enjoy analog output audio at higher quality

- Turn the display off to reduce the effects of the display and display circuit on the analog audio output signal. (🔗 p. 11)
- Turn the digital output off to reduce the effects of the digital audio output circuit on the analog audio output signal. (🔗 p. 12)
- The headphones circuit operation can be stopped to minimize noise from the headphones circuit which could interfere with the analog audio output signal. Set “Off” to the “Phones”. (🔗 p. 24)

I want to turn the illumination lamp off

- Change the settings so that the illumination lamp is always off. (🔗 p. 11)

I want to display Super Audio CD text

- This unit supports Super Audio CD text. Press the INFO button to switch the display information. (🔗 p. 14)

I want to play the multi-channel area of a Super Audio CD is played

- This unit can play multi-channel audio by downmixing to two channels. Press the SOUND MODE button and set “MULTI”. (🔗 p. 12)

I want to play all tracks on a DVD-R/-RW/+R/+RW or CD-R/-RW at random

- Random playback can be set by pressing the MODE/TRIM button and setting “All Mode” as the playback mode before playback. (🔗 p. 15)

I want to playback just the specified folder

- The MODE/TRIM button to set the playback range to “Folder mode”. (🔗 p. 15), (🔗 p. 17))

I want to stop the USB memory device from automatically starting playback

- Set “Off” to the “Resume Play”. (🔗 p. 24)

I want to use this unit’s remote control to operate a Marantz amplifier

- Press the REMOTE MODE AMP button to switch the remote control to the amplifier operating mode. (🔗 p. 7)
- Also, refer to the instruction manual of the amplifier.

Troubleshooting



If a problem should arise, first check the following.

1. **Are the connections correct?**
2. **Is the unit being operated as described in the owner's manual?**
3. **Are the other devices operating properly?**

If this unit does not operate properly, check the items listed in the table below.

Should the problem persist, there may be a malfunction. In this case, disconnect the power immediately and contact your store of purchase.

❑ Power does not turn on / Power is turned off

Symptom	Cause / Solution	Page
Power is not turned on.	• Check whether the power plug is correctly inserted into the power outlet.	<u>10</u>
	• This unit is in standby mode. Press the  CD button on the remote control.	<u>11</u>
Power automatically turns off.	• The Auto Standby mode is set. The Auto Standby mode switches the unit to standby mode when the unit is not operated for approximately 30 minutes. To disable Auto Standby mode, set "Auto Standby" on the menu to "Off".	<u>24</u>
The power turns off and the power indicator blinks in red when a USB memory device is connected.	• The connected USB memory device is not supported. Please use a USB memory device with an operating current that is less than 1A.	—
	• The device requires more power than can be supplied by this unit via USB. Press  on this unit to turn the power off, remove the USB memory device and then turn the power on again.	—

❑ Operations cannot be performed through the remote control unit

Symptom	Cause / Solution	Page
Operations cannot be performed through the remote control unit.	• Batteries are worn out. Replace with new batteries.	<u>2</u>
	• Operate the remote control unit within a distance of about 7 m from this unit and at an angle of within 30°.	<u>2</u>
	• Remove any obstacle between this unit and the remote control unit.	—
	• Insert the batteries in the proper direction, checking the \oplus and \ominus marks.	<u>2</u>
	• The unit's remote control sensor is exposed to strong light (direct sunlight, inverter type fluorescent bulb light, etc.). Move the unit to a place in which the remote control sensor will not be exposed to strong light.	—
	• When using a 3D video device, the remote control unit of this unit may not function due to effects of infrared communications between units (such as TV and glasses for 3D viewing). In this case, adjust the direction of units with the 3D communications function and their distance to ensure they do not affect operations from the remote control unit of this unit.	—
	• Press the REMOTE MODE CD button to switch the remote control operating mode to "CD".	<u>7</u>
	• When using this unit independently, set the switch to "INTERNAL".	<u>10</u>

❑ Display on this unit shows nothing

Symptom	Cause / Solution	Page
Display is off.	<ul style="list-style-type: none"> Press the DISPLAY button to turn on the display. 	<u>11</u>

❑ No sound comes out

Symptom	Cause / Solution	Page
No sound is produced. Or sound is distorted.	<ul style="list-style-type: none"> Check the connections for all devices. 	<u>8</u>
	<ul style="list-style-type: none"> Insert connection cables all the way in. 	—
	<ul style="list-style-type: none"> Check that input connectors and output connectors are not reversely connected. 	—
	<ul style="list-style-type: none"> Check cables for damage. 	—
	<ul style="list-style-type: none"> Check the amplifier's functions and controls and adjust as necessary. 	—
	<ul style="list-style-type: none"> When connecting to a device with digital audio input connectors, set "Digital Out" to "On". 	<u>12</u>
	<ul style="list-style-type: none"> Digital audio output stops when playing the HD layer of a Super Audio CD or a file with a DSD signal or a linear PCM signal with a sampling frequency of 352.8 kHz or higher. 	—
	<ul style="list-style-type: none"> If using headphones, check that "Phones" is set to "On" in the menu. Sound is not output through the headphones jack if "Off" is set. 	<u>24</u>

❑ Sound is interrupted or noise occurs

Symptom	Cause / Solution	Page
During playback from the CD-R/CD-RW/DVD-R/DVD-RW/DVD+R/DVD+RW, sound is occasionally interrupted.	<ul style="list-style-type: none"> The sound may skip during playback of a CD-R/CD-RW containing a high-resolution audio source. 	—
	<ul style="list-style-type: none"> This may be caused by poor recording conditions, or the disc itself may be of poor quality. Use a correctly recorded disc. 	—
During playback from the USB memory device, sound is occasionally interrupted.	<ul style="list-style-type: none"> When the transfer speed of the USB memory device is slow, sound may occasionally be interrupted. 	—
Sound is interrupted during playback of tracks saved on a computer.	<ul style="list-style-type: none"> Do not start applications other than the player software while playing music on your computer. 	—
	<ul style="list-style-type: none"> The sound may be interrupted depending on the hardware or software configuration of the computer being used. 	—

❑ Desired sound does not come out

Symptom	Cause / Solution	Page
Headphone volume is low.	<ul style="list-style-type: none"> Switch "HP AMP Gain" to "Middle" or "High" if using headphones with high impedance or low sensitivity. 	<u>24</u>

❑ Cannot playback Discs

Symptom	Cause / Solution	Page
Cannot playback when the play button is pressed, or cannot correctly play back a specific part of the disc.	<ul style="list-style-type: none"> The disc is dirty or scratched. Either clean the disc, or insert a different disc. 	35
Cannot playback DVD-R/-RW/+R/+RW or CD-R/CD-RW.	<ul style="list-style-type: none"> Discs cannot be played back unless they have been finalized. Use a finalized disc. 	31
	<ul style="list-style-type: none"> This may be caused by poor recording conditions, or the disc itself may be of poor quality. Use a correctly recorded disc. 	—
	<ul style="list-style-type: none"> Files are created in a format that is not supported by this unit. Check the formats supported by this unit. 	31
“No Disc” is displayed.	<ul style="list-style-type: none"> “No Disc” is displayed if the disc is loaded upside-down or if no disc is loaded. 	34
“Unsupported” is displayed.	<ul style="list-style-type: none"> “Unsupported” is displayed if a disc that cannot be played is loaded. 	34

❑ PC or Mac files cannot be played back

Symptom	Cause / Solution	Page
This unit is not recognized on the computer.	<ul style="list-style-type: none"> Reconnect the USB cable to the USB port on your computer. When this unit is still not recognized after reconnection, connect to a different USB port. 	9
	<ul style="list-style-type: none"> Restart your computer. 	—
	<ul style="list-style-type: none"> Check the OS of your computer. 	18
	<ul style="list-style-type: none"> When your computer is running on Windows, a dedicated driver software should be installed. 	18
This unit is not selected as the playback device.	<ul style="list-style-type: none"> Select this unit as the playback device in the sound settings on the computer. 	18
“Unlock” is displayed.	<ul style="list-style-type: none"> When digital audio signals cannot be detected properly, “Unlock” is displayed. 	21
“Unsupported” is displayed.	<ul style="list-style-type: none"> “Unsupported” is displayed when audio signals that are not supported by this unit are input. Check the settings on your computer or player software. 	21
	<ul style="list-style-type: none"> If the computer you use is “Mac OS”, please check if the “SA-KI RUBY” format is set below “384000.0 Hz” using the “Audio MIDI Setup”. 	21

❑ Audio from digital devices cannot be played back (Coaxial/Optical)

Symptom	Cause / Solution	Page
“Unlock” is displayed.	<ul style="list-style-type: none"> When digital audio signals cannot be detected properly, “Unlock” is displayed. 	22
“Unsupported” is displayed.	<ul style="list-style-type: none"> “Unsupported” is displayed when audio signals that are not supported by this unit are input. Check the audio output signal format from your digital device. 	22

❑ The bit length displayed for files played back from a computer or external device is different from the bit length displayed on this unit

Symptom	Cause / Solution	Page
16-bit is displayed, even for 24-bit file playback.	<ul style="list-style-type: none"> The bit length displayed is the number of bits when input to this unit's D/A converter. For a 24-bit file, it is possible that 16-bit data is transferred. In this case, 16-bit is displayed. 	<u>21</u>

❑ USB memory devices cannot be played back

Symptom	Cause / Solution	Page
"No Device", "Err1: Unsupported", "Err3: hub unsupported" or "Err1: no response" is displayed.	<ul style="list-style-type: none"> This unit may not recognize the USB memory device due to poor connection, etc. Make sure that the connection is made properly by taking actions such as disconnecting and reconnecting the USB memory device. 	<u>9</u>
	<ul style="list-style-type: none"> Mass storage class compatible USB memory devices are supported. 	—
	<ul style="list-style-type: none"> This unit does not support a connection through a USB hub. Connect the USB memory device directly to the USB port. 	—
	<ul style="list-style-type: none"> The USB memory device must be formatted to FAT16 or FAT32. 	—
	<ul style="list-style-type: none"> Not all USB memory devices are guaranteed to work. Some USB memory devices are not recognized. When using a type of portable hard disc drive compatible with the USB connection that requires power from an AC adapter, use the AC adapter that came with the drive. 	—
Files on the USB memory device are not displayed. Or "Err2: No playable files" is displayed.	<ul style="list-style-type: none"> Files of a type not supported by this unit are not displayed. 	<u>33</u>
	<ul style="list-style-type: none"> This unit can display a file structure with up to 8 levels, up to 1,000 folders and up to 2,000 files in 1 folder. Modify the folder structure of the USB memory device. 	<u>33</u>
	<ul style="list-style-type: none"> When multiple partitions exist on the USB memory device, only files on the first partition are displayed. 	—
Files on a USB memory device cannot be played.	<ul style="list-style-type: none"> Files are created in a format that is not supported by this unit. Check the formats supported by this unit. 	<u>33</u>
	<ul style="list-style-type: none"> Files that are copyright protected cannot be played on this unit. 	—
	<ul style="list-style-type: none"> If a file is unplayable, "Unsupported" is displayed and the next file is played. 	—
Files that begin with "." cannot be played.	<ul style="list-style-type: none"> When content created by Mac OS X is copied into a USB memory device, all contents as well as hidden files are copied. Although the extension of this file is the same as the extension of the content, it is actually not the content. Delete this file using another OS such as Windows. 	—





❑ Text informations on the USB memory device are not displayed properly

Symptom	Cause / Solution	Page
The text informations are not displayed properly ("...", etc.).	<ul style="list-style-type: none"> Characters that cannot be displayed have been used. On this unit, characters that cannot be displayed are replaced with a "." (period). 	—

Appendix

Playable media

Discs

Playable media	
Super Audio CD	
CD	
CD-R	
CD-RW	
DVD-R/-RW/+R/+RW	

NOTE

- Some discs and some recording formats cannot be played.
- Non-finalized discs cannot be played.

❑ Super Audio CD

There are three types of Super Audio CDs:

1. Single layer disc
Single layer Super Audio CD with just an HD layer.
2. Dual layer disc
Super Audio CD with two HD layers. Enables long playback at a high audio quality.
3. Hybrid disc
Two-layer Super Audio CD with an HD layer and a CD layer.
The signals on the CD layer can be played on a regular CD player.

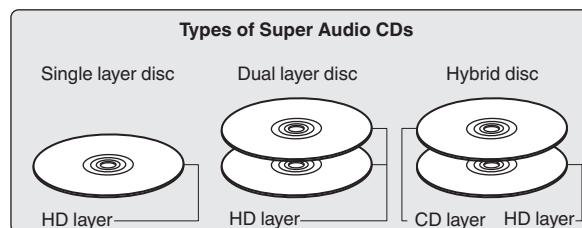

The HD layer is a layer of high density signals for Super Audio CDs.

The CD layer is the layer of signals that can be read on a regular CD player.



- When you press SOUND MODE button and select "MULTI", down-mixed audio is output to the L and R channels.

❑ Maximum number of playable files and folders

Maximum number of folders : 1,000

Maximum number of files in 1 folder : 2,000

NOTE

- Be sure to give files the extension. Files with any other extensions or files with no extensions cannot be played.
- Recordings you have made should only be used for your personal enjoyment, and as per copyright laws may not be used in other ways without permission of the copyright holder.
- Only music files that are not copyright-protected can be played on this unit.
- Content downloaded from pay sites on the Internet are copyright protected. Also, files encoded in WMA format when ripped from a CD, etc. on a computer may be copyright protected, depending on the computer's settings.
- The maximum number of files and folders that can be played differs depending on conditions such as the length of the file name or folder name or the number of levels in the folder hierarchy.

Compatible formats

	Sampling frequency	Bit rate	Bit length	Playable discs			Extension
				CD-R/ CD-RW	DVD-R/ DVD-RW	DVD+R/ DVD+RW	
MP3	44.1/48 kHz	32 – 320 kbps	-	✓	✓	✓	.mp3
WMA	44.1/48 kHz	48 – 320 kbps	-	✓	✓	✓	.wma
AAC	44.1/48 kHz	16 – 320 kbps	-	✓	✓	✓	.aac/ .m4a
WAV	44.1/48/88.2/ 96/176.4/192 kHz	-	16/24 bits	✓*2	✓	✓	.wav
FLAC	44.1/48/88.2/ 96/176.4/192 kHz	-	16/24 bits	✓*2	✓	✓	.flac
Apple Lossless*1	44.1/48/ 88.2/96 kHz	-	16/24 bits	✓*2	✓	✓	.m4a
AIFF	44.1/48/88.2/ 96/176.4/192 kHz	-	16/24 bits	✓*2	✓	✓	.aif/ .aiff
DSD	2.8/5.6 MHz	-	1 bit	-	✓	✓	.dsf/ .dff

*1 The Apple Lossless Audio Codec(ALAC) decoder is distributed under the Apache License, Version 2.0 (<http://www.apache.org/licenses/LICENSE-2.0>).

*2 This item can only be used to play files with a sampling frequency of 44.1/48 kHz.

USB memory device

❑ USB-compatible file systems

FAT16 or FAT32

- If the USB memory device is divided into multiple partitions, only the top drive can be selected.

❑ Maximum number of playable files and folders

Maximum number of folders : 1,000

Maximum number of files in 1 folder : 2,000

❑ Tag data

ID3-TAG (Ver.1.x and 2.x)

WMA-TAG

(The title, artist, and album tag data are supported)

❑ Compatible formats

	Sampling frequency	Bit rate	Bit length	Extension
MP3	44.1/48 kHz	32 – 320 kbps	–	.mp3
WMA	44.1/48 kHz	48 – 320 kbps	–	.wma
AAC	44.1/48 kHz	16 – 320 kbps	–	.aac/ .m4a
WAV	44.1/48/ 88.2/96/ 176.4/192 kHz	–	16/24 bits	.wav
FLAC	44.1/48/ 88.2/96/ 176.4/192 kHz	–	16/24 bits	.flac
Apple Lossless*	44.1/48/ 88.2/96 kHz	–	16/24 bits	.m4a
AIFF	44.1/48/ 88.2/96/ 176.4/192 kHz	–	16/24 bits	.aif/ .aiff
DSD	2.8/5.6 MHz	–	1 bit	.dsf/ .dff

* The Apple Lossless Audio Codec(ALAC) decoder is distributed under the Apache License, Version 2.0 (<http://www.apache.org/licenses/LICENSE-2.0>).

NOTE

- Be sure to give files the extension. Files with any other extensions or files with no extensions cannot be played.
- Recordings you have made should only be used for your personal enjoyment, and as per copyright laws may not be used in other ways without permission of the copyright holder.
- It is not compatible with an MP3 player, digital camera, a USB device for a mobile phone, etc.
- The unit does not support a card reader, USB extension cable, or USB hub.



- Only music files that are not copyright-protected can be played on this unit.
 - Content downloaded from pay sites on the Internet are copyright protected. Also, files encoded in WMA format when ripped from a CD, etc. on a computer may be copyright protected, depending on the computer's settings.
- The maximum number of files and folders that can be played differs depending on conditions such as the length of the file name or folder name or the number of levels in the folder hierarchy.

Playback order of music files

When there are multiple folders containing music files, the playback order of folders is automatically set when this unit reads the media. The files in each folder are played back in the order in which the files were recorded on the media, from the oldest date and time.

DVD-R/-RW/+R/+RW, CD-R/-RW and USB memory device

For playback of files on DVD-R/-RW/+R/+RW, CD-R/-RW or USB memory device, files in all folders on the first layer are played first, next on the second layer, then next on the third layer, and so on in this order.



- The playback order displayed on a PC may differ from the actual playback order.
- The playback order with a DVD-R/-RW/+R/+RW and CD-R/-RW may differ, depending on the writing software.

NOTE

- The playback order may differ from the order in which the folders or files were recorded if you delete or add a folder or file on USB. This occurs because of data recording specifications and is not a malfunction.

About discs and files

Music files recorded on CD-R/-RW, DVD-R/-RW/+R/+RW and USB memory device are divided into large segments (folders) and small segments (files).

Files are stored in folders, and folders can be placed for storage in a hierarchy. The unit can recognize up to 8 levels of folders.

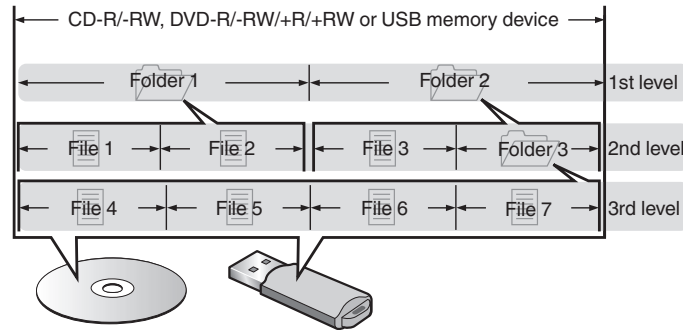

- When writing music files on a DVD-R/-RW/+R/+RW or CD-R/-RW disc, set the writing software's format to "ISO9660". The files may not play properly if they are recorded in other formats. For details, refer to the instructions of your writing software.

Cautions on using media

Loading discs

- Set the disc in the tray label side up.
- Make sure the disc tray is fully open when inserting the disc.
- Place the discs flatly, 12 cm discs in the outer tray guide (Figure 1), 8 cm discs in the inner tray guide (Figure 2).

[Figure 1]

Outer tray guide

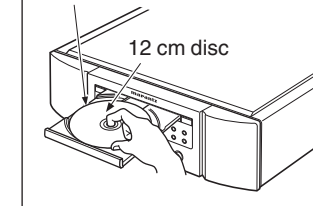

[Figure 2]

Inner tray guide

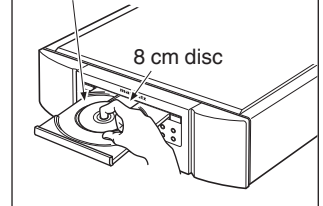

- Place 8 cm discs in the inner tray guide without using an adapter.



- "Unsupported" is displayed if a disc that cannot be played is loaded.
- "No Disc" is displayed if the disc is loaded upside-down or if no disc is loaded.

NOTE

- Only load one disc at a time. Loading two or more discs can damage the unit or scratch the discs.
- Do not use cracked or warped discs or discs that have been repaired with adhesive, etc.
- Do not use discs on which the sticky part of cellophane tape or labels is exposed or on which there are traces of where labels have been removed. Such discs can get caught inside the player and damage it.
- Do not use discs in special shapes, as they may damage the unit.



- Do not push the disc tray in by hand when the power is off. Doing so could damage the unit.
- If the unit is left in a room full of smoke from cigarettes, etc., for long periods of time, the surface of the optical pickup may get dirty, preventing it from receiving signals properly.

How to handle media

- Do not get fingerprints, oil or dirt on discs.
- Take special care not to scratch discs when removing them from their cases.
- Do not bend or heat discs.
- Do not enlarge the hole in the center.
- Do not write on the labeled (printed) surface with ball-point pens, pencils, etc., or stick new labels on discs.
- Condensation may form on discs if they are moved suddenly from a cold place (outdoors for example) to a warm place, but do not try to dry discs with a hairdryer, etc.
- Do not eject a USB memory device or turn off the unit while a USB memory device is being played. This may result in malfunction or loss of the USB memory device's data.
- Do not attempt to open or modify a USB memory device.
- USB memory device and files can be damaged by static electricity. Do not touch the metal contacts of a USB memory device with your fingers.
- Do not use warped USB memory device.
- After use, be sure to remove any disc or USB memory device, and store it in its proper case, to avoid dust, scratches and deformation.
- Do not store discs in the following places:
 1. Places exposed to direct sunlight for long periods of time
 2. Dusty or humid places
 3. Places exposed to heat from heaters, etc.

Cleaning discs

- If there are fingerprints or dirt on a disc, wipe them off before using the disc.
- Use a commercially available disc cleaning set or a soft cloth to clean discs.

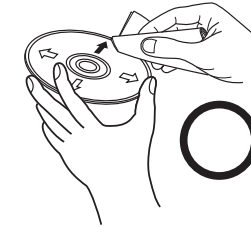

Gently wipe the disc from the inside towards the outside.

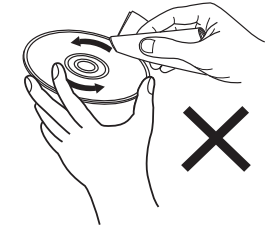

Do not wipe with a circular motion.

NOTE

- Do not use record spray, antistatic agents, benzene, thinner or other solvents.

D/A converter

Specifications of supported audio formats

□ USB-DAC

	Sampling frequency	Bit length
DSD (2-channel)	2.8/5.6/ 11.2 MHz	1 bit
Linear PCM (2-channel)	44.1/48/88.2/96/ 176.4/192/352.8/ 384 kHz	16/24/32 bits

NOTE

- Digital audio output stops during playback of the DSD files and linear PCM signals with a sampling frequency of 352.8/384 kHz using this unit's D/A converter.

□ Coaxial/Optical

	Sampling frequency	Bit length
Linear PCM (2-channel)	44.1/48/88.2/96/ 176.4/192 kHz	16/24 bits

Explanation of terms

AIFF (Audio Interchange File Format)

This is an uncompressed and lossless format for digital audio. Use AIFF files to burn high-quality audio CDs from imported songs. AIFF files use approximately 10 MB of disk space per minute.

Apple Lossless Audio Codec

This is a codec for lossless audio compression method developed by Apple Inc. This codec can be played back on iTunes, iPod or iPhone. Data compressed to approximately 60 – 70 % can be decompressed to exactly the same original data.

DSD (Direct-Stream Digital)

One of the audio data recording methods, it is the signal aspect used to store audio signals on a super audio CD, and is Δ - Σ modulated digital audio.

FLAC

FLAC stands for Free lossless Audio Codec, and is a lossless free audio file format. Lossless means that the audio is compressed without any loss in quality.

The FLAC license is as shown below.

Copyright (C) 2000, 2001, 2002, 2003, 2004, 2005, 2006, 2007, 2008, 2009 Josh Coalson

Redistribution and use in source and binary forms, with or without modification, are permitted provided that the following conditions are met:

- Redistributions of source code must retain the above copyright notice, this list of conditions and the following disclaimer.
- Redistributions in binary form must reproduce the above copyright notice, this list of conditions and the following disclaimer in the documentation and/or other materials provided with the distribution.
- Neither the name of the Xiph.org Foundation nor the names of its contributors may be used to endorse or promote products derived from this software without specific prior written permission.

THIS SOFTWARE IS PROVIDED BY THE COPYRIGHT HOLDERS AND CONTRIBUTORS "AS IS" AND ANY EXPRESS OR IMPLIED WARRANTIES, INCLUDING, BUT NOT LIMITED TO, THE IMPLIED WARRANTIES OF MERCHANTABILITY AND FITNESS FOR A PARTICULAR PURPOSE ARE DISCLAIMED. IN NO EVENT SHALL THE FOUNDATION OR CONTRIBUTORS BE LIABLE FOR ANY DIRECT, INDIRECT, INCIDENTAL, SPECIAL, EXEMPLARY, OR CONSEQUENTIAL DAMAGES (INCLUDING, BUT NOT LIMITED TO, PROCUREMENT OF SUBSTITUTE GOODS OR SERVICES; LOSS OF USE, DATA, OR PROFITS; OR BUSINESS INTERRUPTION) HOWEVER CAUSED AND ON ANY THEORY OF LIABILITY, WHETHER IN CONTRACT, STRICT LIABILITY, OR TORT (INCLUDING NEGLIGENCE OR OTHERWISE) ARISING IN ANY WAY OUT OF THE USE OF THIS SOFTWARE, EVEN IF ADVISED OF THE POSSIBILITY OF SUCH DAMAGE.

MP3 (MPEG Audio Layer-3)

This is an internationally standardized audio data compression scheme, using the “MPEG-1” video compression standard. It compresses the data volume to about one eleventh its original size while maintaining sound quality equivalent to a music CD.

WMA (Windows Media Audio)

This is audio compression technology developed by Microsoft Corporation.

WMA data can be encoded using Windows Media® Player. To encode WMA files, only use applications authorized by Microsoft Corporation. If you use an unauthorized application, the file may not work properly.

Sampling frequency

Sampling involves taking a reading of a sound wave (analog signal) at regular intervals and expressing the height of the wave at each reading in digitized format (producing a digital signal).

The number of readings taken in one second is called the “sampling frequency”. The larger the value, the closer the reproduced sound is to the original.

Dynamic range

The difference between the maximum undistorted sound level and the minimum discernible level above the noise emitted by the device.

Bit rate

This is the amount of audio data recorded on a disc that is read in one second.

Finalizing

This process enables DVD/CD recorded with a recorder to be played by other players.

Linear PCM

This is an uncompressed PCM (Pulse Code Modulation) signal. Unlike lossy compression audio sources such as MP3, no audio quality or dynamic range deteriorates.

Trademark information



Adobe, the Adobe logo and Reader are either registered trademarks or trademarks of Adobe Systems Incorporated in the United States and/or other countries.

Specifications

□ Audio performance

• Analog output

	[Super Audio CD]	[CD]
Channels:	2-channels	2-channels
Playable frequency range:	2 Hz – 100 kHz	2 Hz – 20 kHz
Playable frequency response:	2 Hz – 50 kHz (-3 dB)	2 Hz – 20 kHz (±1 dB)
S/N ratio:	112 dB (Audible range)	104 dB
Dynamic range:	109 dB (Audible range)	98 dB
Harmonic distortion:	0.0008 % (1 kHz, Audible range)	0.0015 % (1 kHz)
Wow & flutter:	Crystal accuracy	Crystal accuracy
• Output level		
Unbalanced:	2.4 V (10 k Ω /kohms)	2.0 V (10 k Ω /kohms)
Headphone output:	50 mW/32 Ω /ohms (variable maximum)	50 mW/32 Ω /ohms (variable maximum)
• Digital output		
Coaxial:	-	0.5 Vp-p / 75 Ω /ohms
Optical:	-	-19 dBm
• Optical readout system		
Laser:	AlGaAs	AlGaAs
Wave length:	650 nm	780 nm
Signal type:	1-bit DSD	16-bit linear PCM
Sampling frequency:	2.8224 MHz	44.1 kHz

□ General

Power supply:	AC 230 V, 50/60 Hz
Power consumption:	47 W
Power consumption in standby mode:	0.3 W or less
Operating temperature:	+5 °C - +35 °C
Operating humidity:	5 – 90 % (without dew)

For the purpose of improvement, the specifications and design are subject to change without notice.

□ Dimensions (Unit : mm)

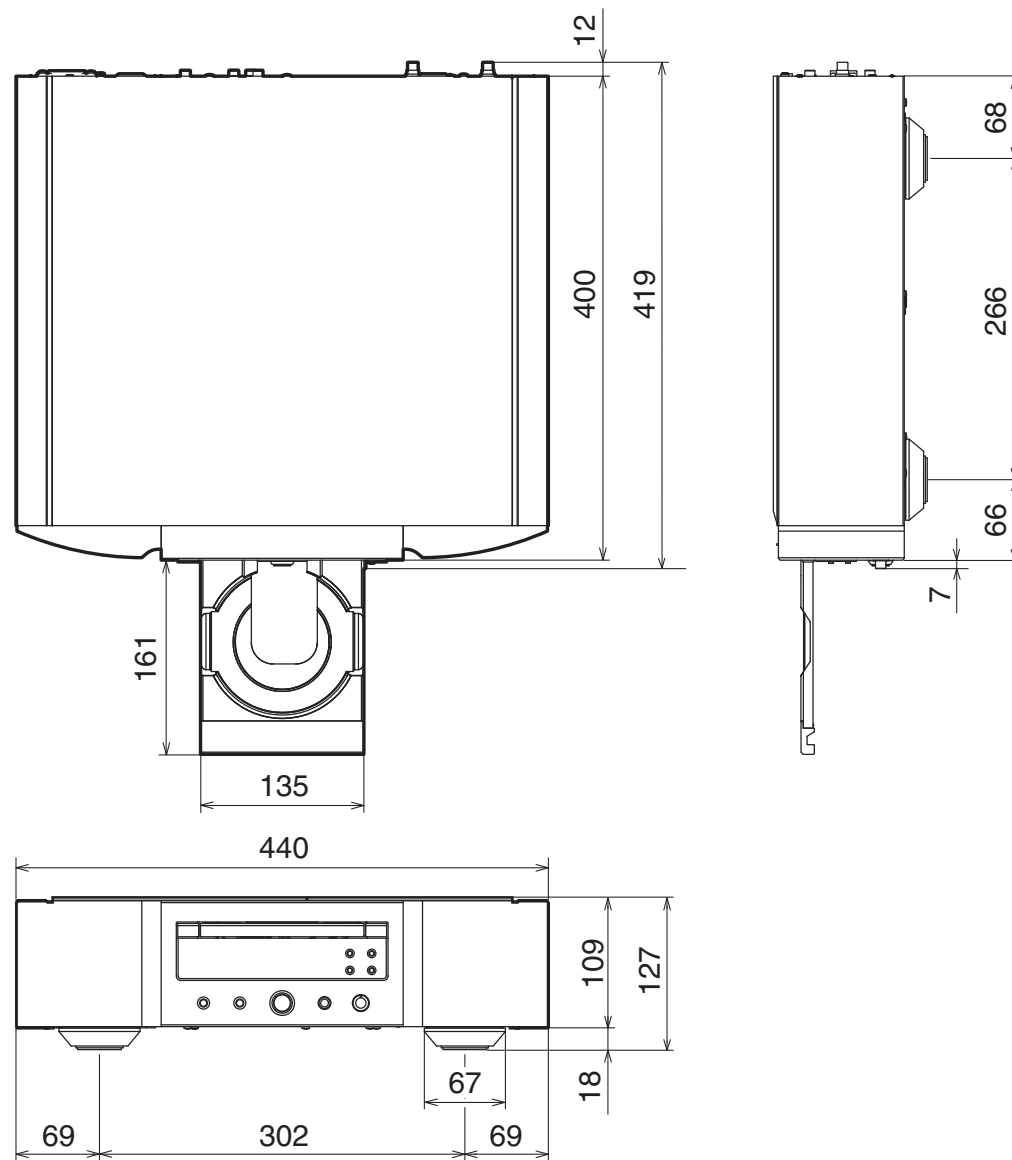

□ Weight : 17.1 kg

Index

A		F		R	
Amplifier	8	Front panel	4	Rear panel	6
Auto Standby	24			Remote control	10
AV receiver	8	M		Remote control unit	7
		Menu map	23		
C		P		T	
CD	13	PC	9	Timer device	10
		Program playback	14	Tips	26
D				Troubleshooting	27
D/A converter	8, 18				
DATA CD	15	U			
Display	5	USB memory device	9, 16		
Display's brightness	11				

www.marantz.com

You can find your nearest authorized distributor or dealer on our website.

marantz[®] is a registered trademark.

3520 10601 10AM

Copyright © 2018 D&M Holdings Inc. All Rights Reserved.